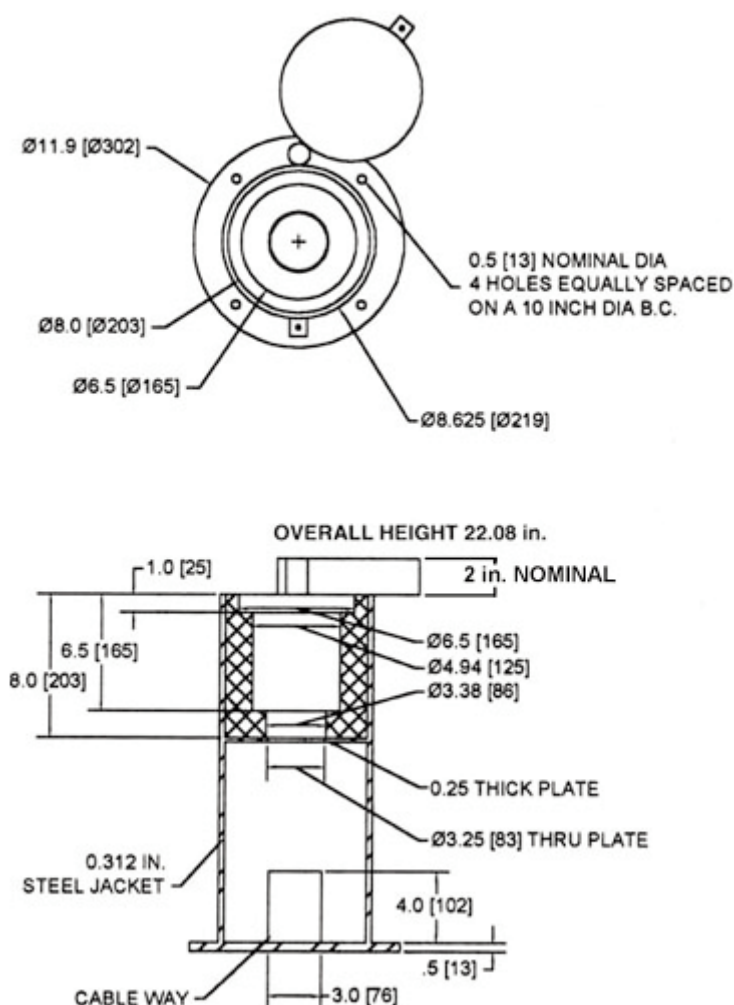

Table top lead shield with cable-way. A clamp mechanism is provided to hold the Detector/PMT assembly in place with room for any of the ORTEC PMT bases to be coupled to the PMT.

Shipping weight: 300 lbs.



Specifications subject to change  
060217